

Bunny in the Garden Quilt

Please read instructions carefully before cutting

Materials

- 1m Whimsy Prints - Meadow (A)
- 1.1m Whimsy Prints - Robin's Egg (B)
- 1.5m Whimsy Prints - Blush * (C)
- 3.1m Whimsy Prints - Taupe (D)

*Includes Binding

Cutting Instructions

Please note: All strips are cut across the width of fabric (WOF) from selvage to selvage unless otherwise noted.

From the Whimsy Print - Meadow (A), cut:

- (3) 5¹/₂" x WOF strips. Sub-cut (21) 5¹/₂" x 5¹/₂" squares.
- Remaining fabric is for paper piecing

From the Whimsy Print - Robin's Egg (B), cut:

- (4) 5¹/₂" x WOF strips. Sub-cut (22) 5¹/₂" x 5¹/₂" squares.
- Remaining fabric is for paper piecing.

From the Whimsy Print - Blush (C), cut:

- (4) 5¹/₂" x WOF strips. Sub-cut (23) 5¹/₂" x 5¹/₂" squares.
- (8) 2¹/₄" x WOF strips for the binding.
- Remaining fabric is for paper piecing.

From the Whimsy Print - Taupe (D), cut:

- (4) 5¹/₂" x WOF strips. Sub-cut (25) 5¹/₂" x 5¹/₂" squares.
- (2) 5¹/₄" x 70" strips.
- (2) 5¹/₄" x 85¹/₂" strips.
- (4) 10¹/₂" x WOF stripes. Sub-cut (52) 10¹/₂" x 3" rectangles. To be used for Tulip Pattern pieces A + G.
- Remaining fabric is for paper piecing.

Block Assembly

Sew (1) C, (1) A, (1) D and (1) B together to create Block 1. Repeat to make (3) Block 1 squares total.

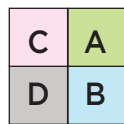

Block 1
Make 3

Sew (1) A, (1) D, (1) B and (1) C together to create Block 2. Repeat to make (3) Block 2 squares total.

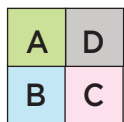

Block 2
Make 3

Sew (1) B, (1) C, (1) A and (1) D together to create Block 3. Repeat to make (3) Block 3 squares total.

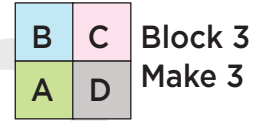

Row 1

Make 1

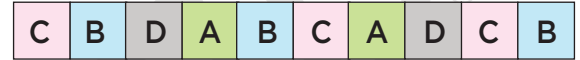

Sew (1) C, (1) B, (1) D, (1) A, (1) B, (1) C, (1) A, (1) D, (1) C, (1) B together to create Row 1

Row 2

Make 1



Sew (1) C, (1) A, (1) D, (1) C, (1) B, (1) D, (1) B, (1) D, (1) C, (1) A together to create Row 2

Row 3

Make 1



Sew (1) A, (1) D, (1) C, (1) B, (1) D, (1) A, (1) B, (1) C, (1) A, (1) D, (1) C, (1) B together to create Row 3

Row 4

Make 1



Sew (1) D, (1) B, (1) C, (1) A, (1) D, (1) C, (1) B, (1) D, (1) B, (1) D, (1) C, (1) A together to create Row 4

Row 5

Make 1



Sew (1) A, (1) D, (1) C, (1) B, (1) D, (1) A, (1) D, (1) B together to create Row 5

Row 6

Make 1

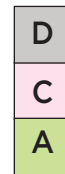

Sew (1) D, (1) C, (1) A together to create Row 6

Foundation Paper Piecing

Use the Tulip Pattern to create (13) (C) Tulips and (13) (B) Tulips.

Piece numerically then join sections alphabetically.

Use the Bunny Pattern to create (1) Bunny Rabbit. Piece numerically then join sections alphabetically.

For more detailed instructions visit our blog.

©Fabricland 2020.

This pattern is not available for commercial resale. You cannot copy and sell or digitally distribute this pattern. You may sell items you make with this pattern.

Bunny in the Garden Quilt

Quilt Layout

Quilt Top Assembly

*Follow Quilt Layout while assembling quilt top.

- Use Quilt Layout for block location.
- Sew blocks and rows together to create Centre block.
- Sew (1) $5\frac{1}{4}'' \times 85\frac{1}{2}''$ strip to each side of the Centre block.
Sew (1) $5\frac{1}{4}'' \times 70''$ strip to the top and to the bottom of the Centre block to make the quilt top.
- Layer and quilt as desired.
- Sew the (8) $2\frac{1}{2}'' \times \text{WOF}$ strips together, end to end with 45-degree seams, to make the binding. Fold this long strip in half lengthwise the wrong side together and press.
- Bind as desired.

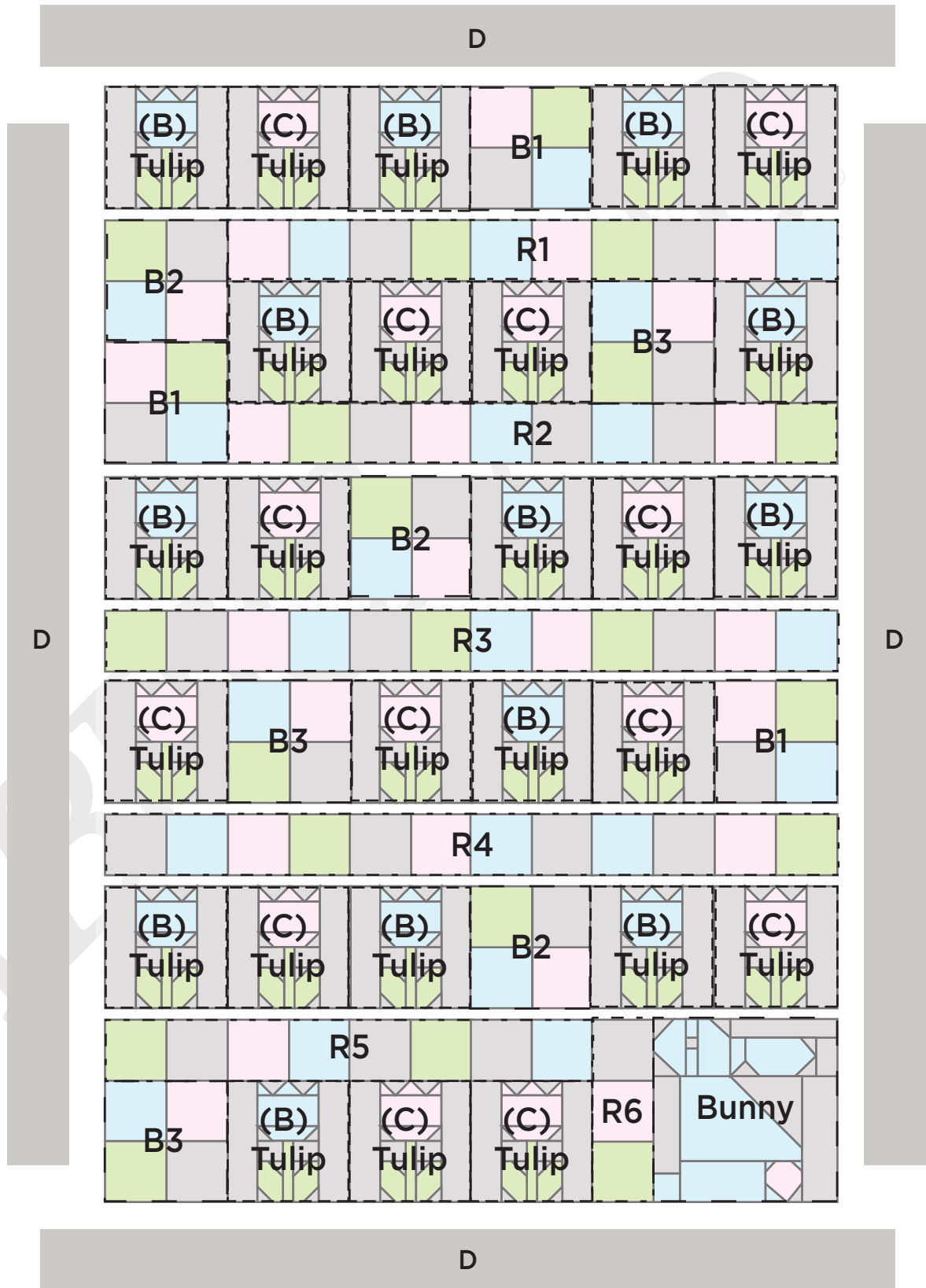

©Fabricland 2020.

This pattern is not available for commercial resale. You cannot copy and sell or digitally distribute this pattern. You may sell items you make with this pattern.

Finished Quilt size: $70'' \times 95''$

Bunny in the Garden Quilt

Foundation Paper Piecing

Bunny Pattern:

To create Bunny Rabbit piece numerically then join sections alphabetically.

For more detailed instructions visit our blog.

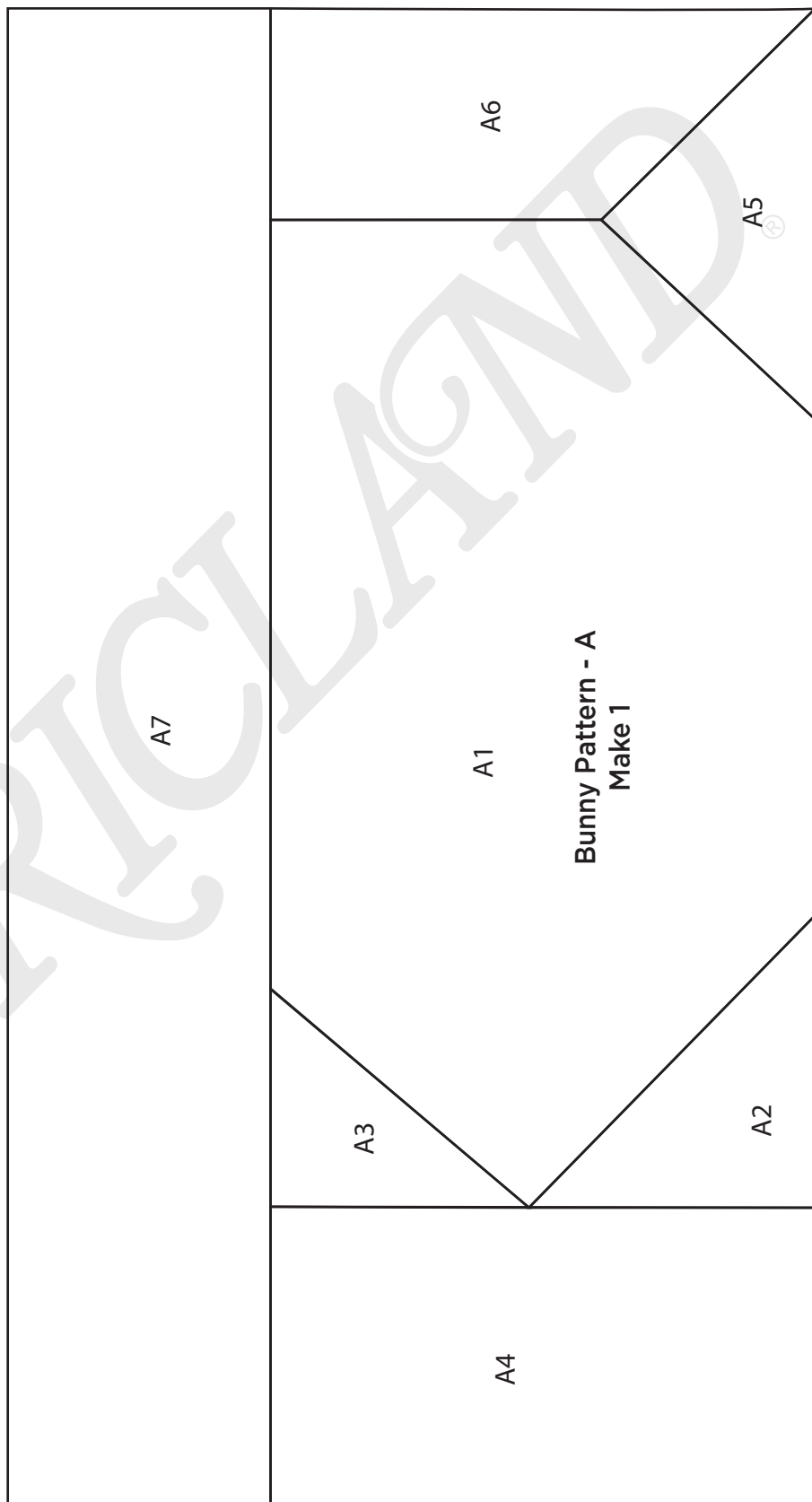
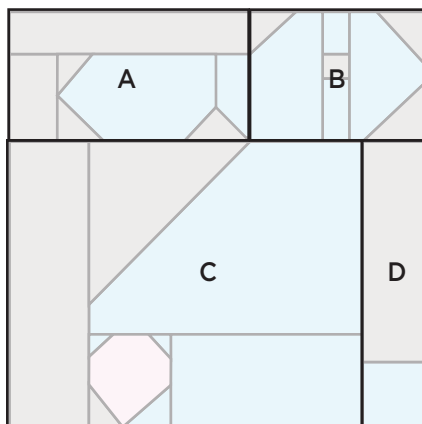

Actual Pattern Size

©Fabricland 2020.

This pattern is not available for commercial resale. You cannot copy and sell or digitally distribute this pattern. You may sell items you make with this pattern.

Bunny in the Garden Quilt

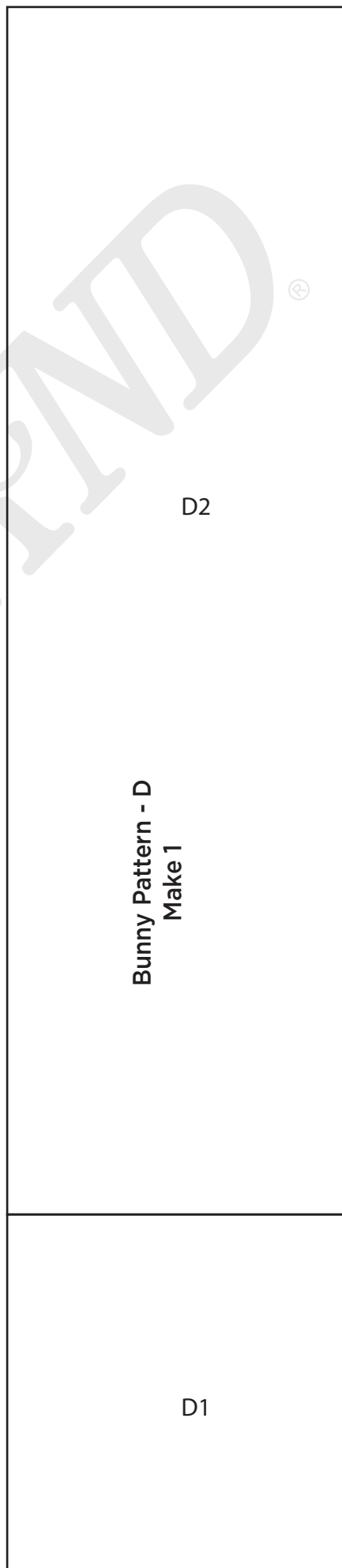
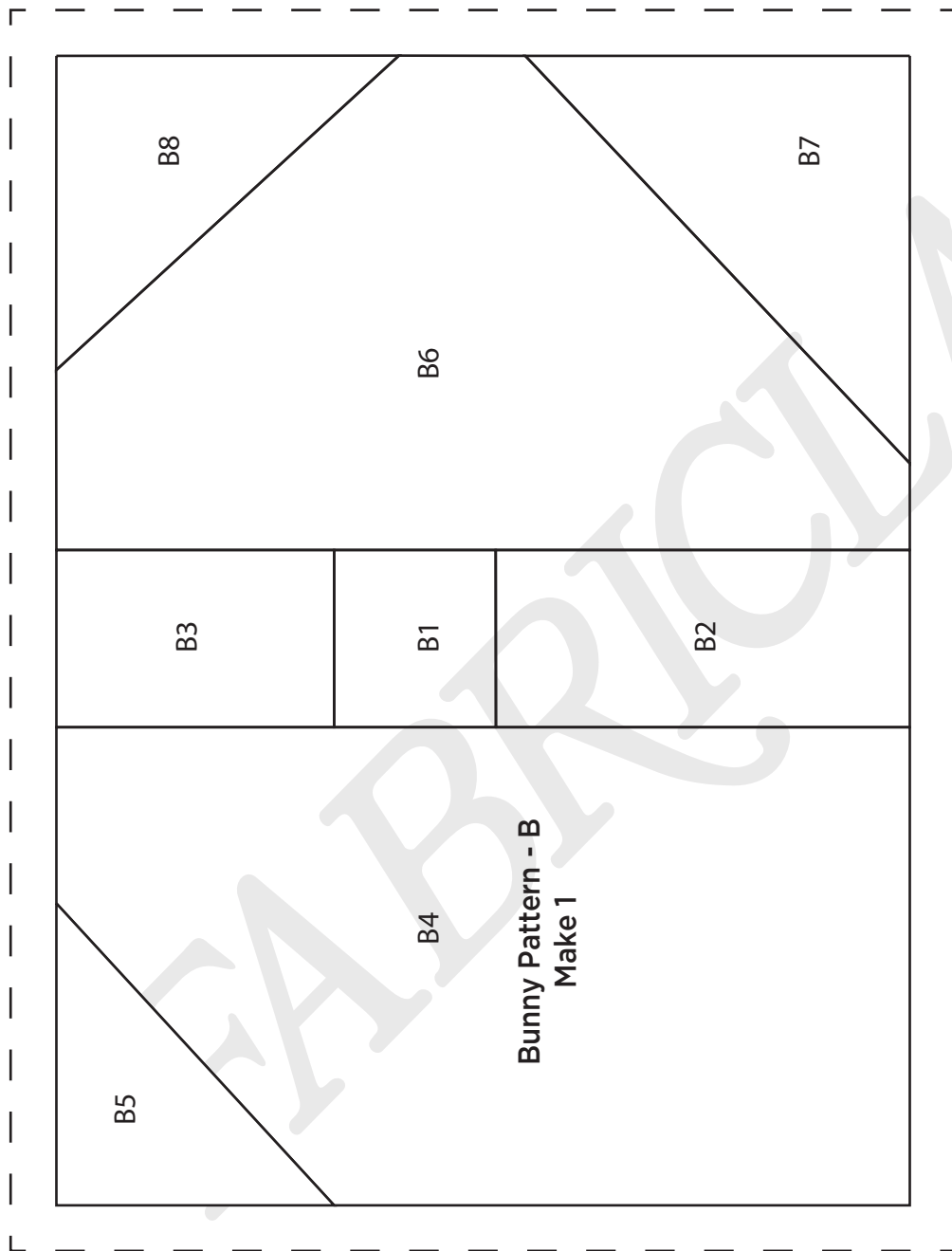

Actual Pattern Size

©Fabricland 2020.

This pattern is not available for commercial resale. You cannot copy and sell or digitally distribute this pattern. You may sell items you make with this pattern.

Bunny in the Garden Quilt

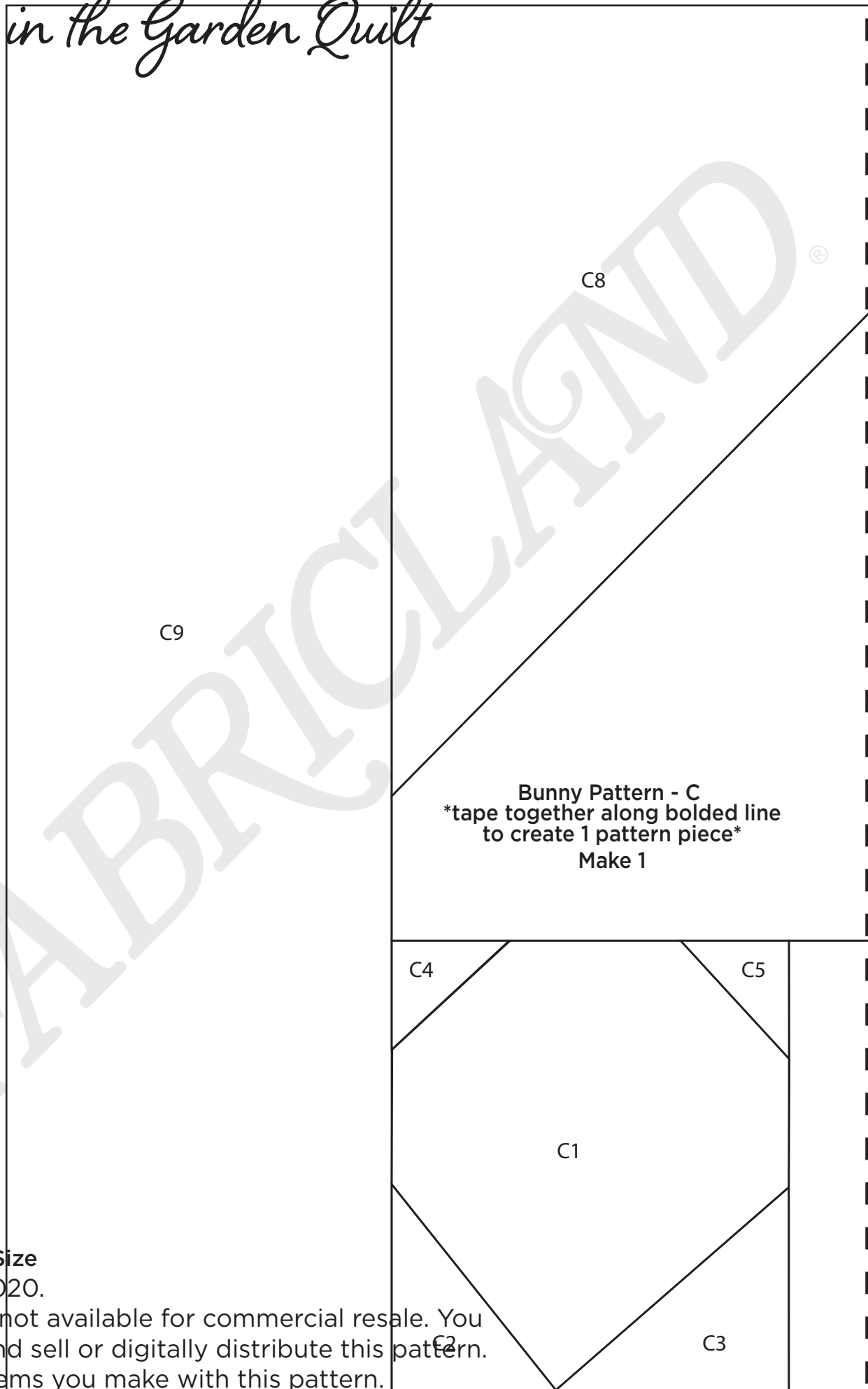

Bunny Pattern - C
***tape together along bolded line**
to create 1 pattern piece*
Make 1

Actual Pattern Size
©Fabricland 2020.

This pattern is not available for commercial resale. You cannot copy and sell or digitally distribute this pattern. You may sell items you make with this pattern.

Bunny in the Garden Quilt

C7

Bunny Pattern - C
*tape together along bolded line
to create 1 pattern piece*
Make 1

C6

Actual Pattern Size

©Fabricland 2020.

This pattern is not available for commercial resale. You cannot copy and sell or digitally distribute this pattern. You may sell items you make with this pattern.

Bunny in the Garden Quilt

Foundation Paper Piecing

Tulip Pattern:

To create **(B)** Tulips and **(C)** Tulips.
 Piece numerically then join sections
 alphabetically.
 Reprint and repeat as needed.

For more
 detailed
 instructions
 visit our
 blog.

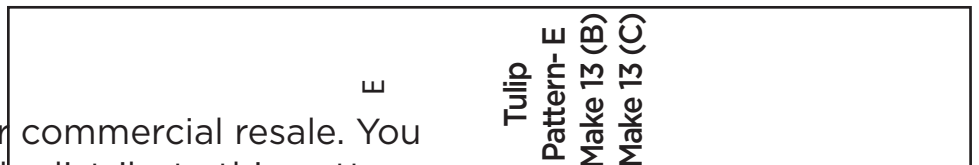
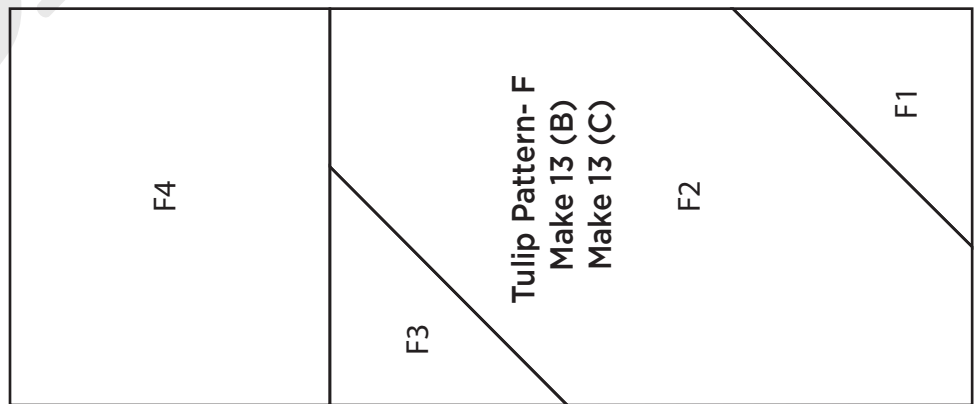
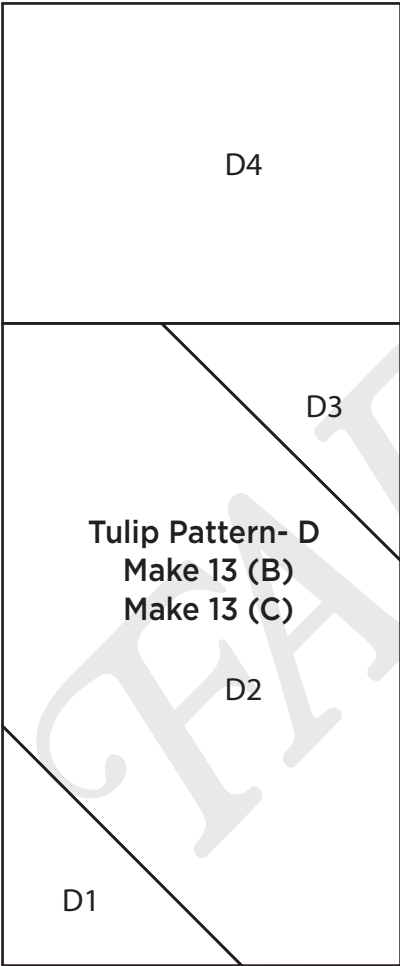
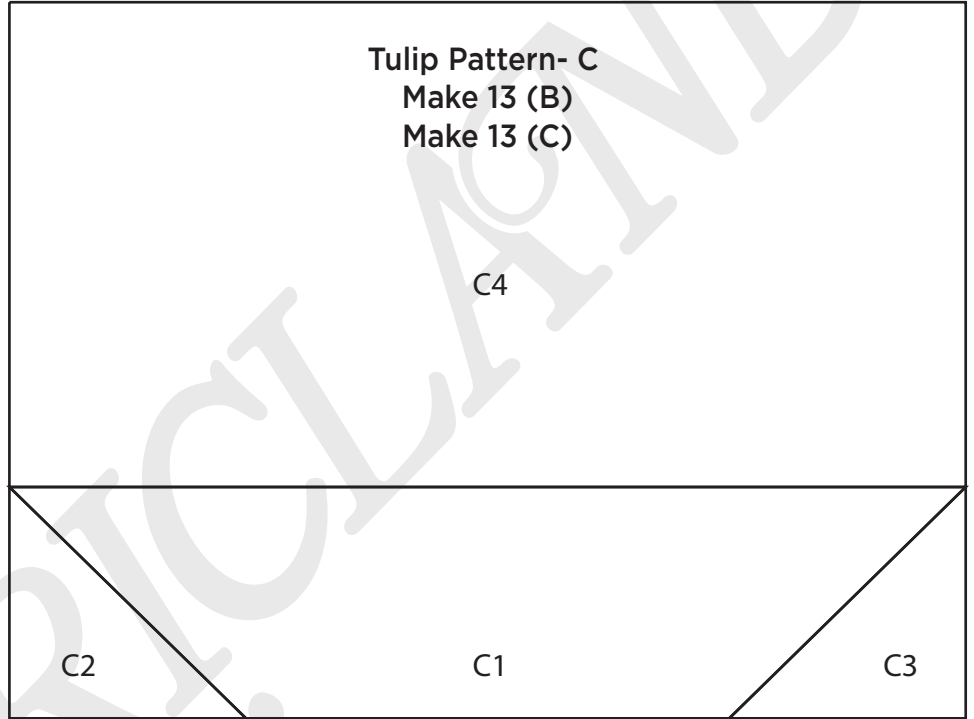
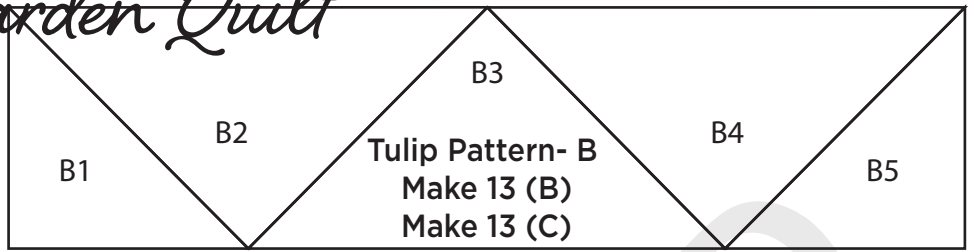
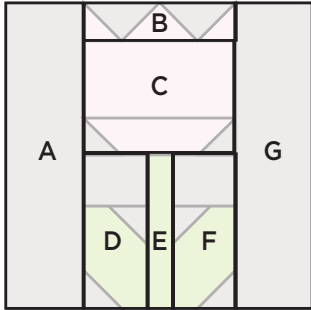

Actual Pattern Size

©Fabricland 2020.

This pattern is not available for commercial resale. You cannot copy and sell or digitally distribute this pattern. You may sell items you make with this pattern.

Bunny in the Garden Quilt

A

Tulip Pattern- A
Make 13 (B)
Make 13 (C)

G

Tulip Pattern- G
Make 13 (B)
Make 13 (C)

Actual Pattern Size

©Fabricland 2020.

This pattern is not available for commercial resale. You cannot copy and sell or digitally distribute this pattern.

You may sell items you make with this pattern.